

Color Touch Heating Thermostat

- This Thermostat is a digital thermostat, which is designed for electric floor heating system or water heating system. Using 4.3inch color touch LCD display, the working status can be easily understood. With built-in four languages, you can select the languages you want to display.
- With five modes, the system can work according to your desired pre-set temperature conveniently. And the 5+1+1 days programmable function, which is easy-to-program on/off settings per day.
- Simple regulation which sends On/Off commands to the heating system according to a pre-selected temperature variation. The thermostat control algorithm includes an anticipation function which reduces the discrepancy between the thermostat reading and the temperature at the centre of the room.
- Choose from three (3) sensor setting: Ambient (built-in sensor)- to control the air temperature; Floor - to control the temperature using the floor probe; Ambient and Floor - to control the ambient air, and show floor temperature by using the floor probe.

Product Features

- 4.3inch Color Touch Screen Operation
- Electric Heating System(Max.16A) or Water Heating System(Max.3A)
- Adjustable Comfort Mode, Economy Mode, Party Mode, Holiday Mode and Program Mode Control
- 5+1+1 Days Programmable
- External and Internal Sensor Select
- Four languages select: English, French, Germany, Dutch
- Clock and Date Display
- Temp. Calibration
- Temp. Protection
- 86*86mm mounting

Technical Data

- Voltage: 230V, 50/60Hz
- Load Current: 16A(Max)
- Temp. Setting Range: 5~35°C
- Ambient: 0~50°C
- Sensor: NTC10K, 3950ohms at 25°C
- Accuracy: ± 0.5°C
- Protection Class: IP30

Screen and Display

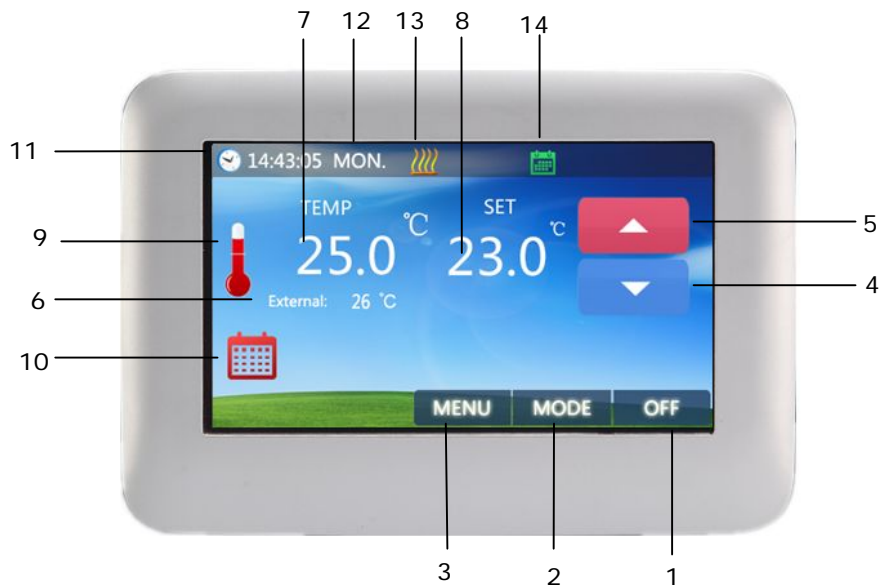



| | | |
|----|-----------------------------|----------------------------------------------------------------------------------|
| 1 | ON/OFF Button | Use to turn on/off Thermostat |
| 2 | Mode Button | Use to Choose Working Mode |
| 3 | Menu Button | Use to Menu Settings |
| 4 | Down Button | Decrease Temp. or other parameter setting |
| 5 | Up Button | Increase Temp. or other parameter setting |
| 6 | External Temp. | Show Floor Temp. |
| 7 | Room Temp. | Show Actual Room Temp. |
| 8 | Set Temp. | Range: 5-35°C |
| 9 | Room Temp. Icon | Room Temp. Icon |
| 10 | Mode Icon | Show Current Working Mode |
| 11 | Clock Icon | Show Current Time & Enter Parameter Setting |
| 12 | Weekday Icon | Show Current Weekday |
| 13 | Heating Icon | Will Show When in Heating |
| 14 | Mode Icon | Show Current Working Mode |
| 15 | Date & Time Button | Use to Set Weekday and Time |
| 16 | PRG. Schedule Review Button | Use to Check 5+1+1 Days Programmable Schedule |
| 17 | Mode Temp. Pre-set Button | Use to Pre-set Mode's Working Temp. |
| 18 | Language Select Button | Use to Select English, French, German & Dutch Language |
| 19 | Protection Temp. Set Button | Use to Set Over Protection Temp. & Low Protection Temp. |
| 20 | Comfort Mode Button | Once Select, Thermostat Will Work According to Pre-set Temp. of Comfort Mode. |
| 21 | Economy Mode Button | Once Select, Thermostat Will Work According to Pre-set Temp. of Economy Mode. |
| 22 | Party Mode Button | Once Select, Thermostat Will Work According to Pre-set Temp. of Party Mode. |
| 23 | Holiday Mode Button | Once Select, Thermostat Will Work According to Pre-set Temp. of Holiday Mode. |
| 24 | PRG. Mode Button | Once Select, Thermostat Will Work According to Pre-set Temp. of 5+1+1 PRG. Mode. |

Schedule Setting



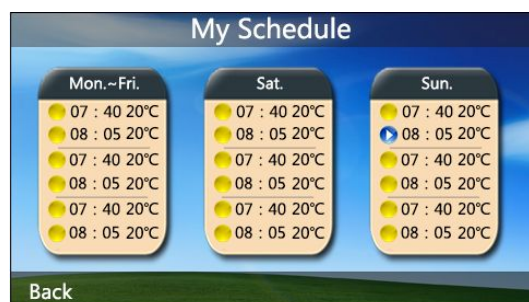

Schedule Review & Edit

Press Menus Button, press  , then you can review weekly schedule. You can press the three column to change the 5+1+1 events.

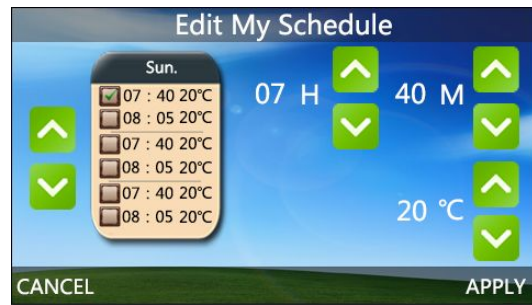



For example, if you want to edit Sat. schedule, you can press Sat. column, then you will enter the edit page as picture shows. Every setting can be finish by pressing  or  button.





1. In Sun. column, there are six periods. You can press  or  button to choose the period you are going to change. Whichever period is selected,  will display.
2. After period is selected, you can set hour, minute and temperature by pressing  and  button.
3. After new schedule is set, pls. press “APPLY” to save the new schedule.

Edit Date and Time

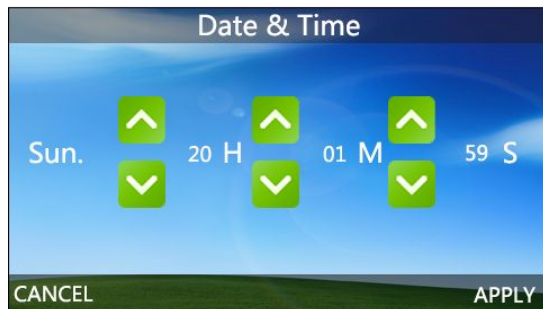
Press Menu button, choose  button to edit date and time by  or  button. After setting pls. press “APPLY” to save the changes.





Mode Pre-set Temp. Settings

Press Menu button, choose  button to pre-set mode working temp. by  and  Button. After setting, pls. press “APPLY” to save the changes.



Protection Settings

Press Menu then select  button to enter Protection Settings page. You can set High Protection temp. & Low Protection temp. by  and  button. After setting, pls. press “APPLY” to save the changes.

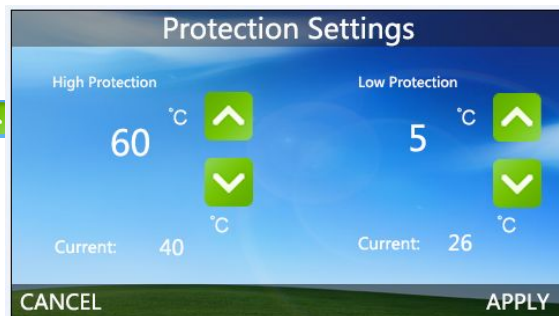

High Protection: It uses external sensor to probe floor temp. When floor temp. over set protection temp. the system will be shut off automatically.

Low Protection: It functions only when thermostat under OFF mode. It uses internal sensor to probe room temp. When room temp. below set protection temp, then the system will be shut on automatically.

Languages Select

Press Menu button, then select  icon to enter languages select page, after selecting the language you want, press “APPLY” to save it.



Parameter Settings

Within 3S after turning thermostat to OFF mode, press  for 2 seconds, then will enter parameter setting, you can set the desired value by pressing “<<” or “>>”, and go to other pages by pressing “Pre” or “Next”.

| <u>Menu</u> | <u>Description</u> | <u>Range</u> |
|-------------|---------------------------------------------|-------------------------------|
| 01 | Temp. Offset | -8 °C ~8°C |
| 02 | Dead Zone | 0°C ~3°C |
| 03 | Set Point Max. | 5 °C ~35°C |
| 04 | Set Point Min. | 5 °C ~35°C |
| 05 | NTC Select(Internal, External) | I only, E only, I & E, I or E |
| 06 | Low Protection Max. | 5 °C ~10°C |
| 07 | Low Protection Min. | 5 °C ~10°C |
| 08 | High Protection Max. | 5 °C ~90°C |
| 09 | High Protection Min. | 5 °C ~90°C |
| 10 | Backlight off Time after Operation. | 3s~180s |
| 11 | Min. Backlight Brightness of Standby Status | 1%~100% |
| 12 | Relay Delay Time | 0s~250s |
| 13 | Relay Output | Normal(NO); Inverted(NC) |
| 14 | Restore | << or >> |

Wiring Diagrams

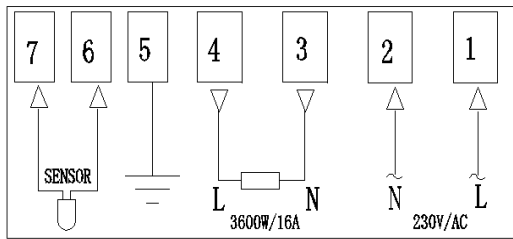

Installation

Using a screw driver to open the upper and lower body part, then connect the wiring to terminals tightly, then fix the lower body part into wall with attached screws.

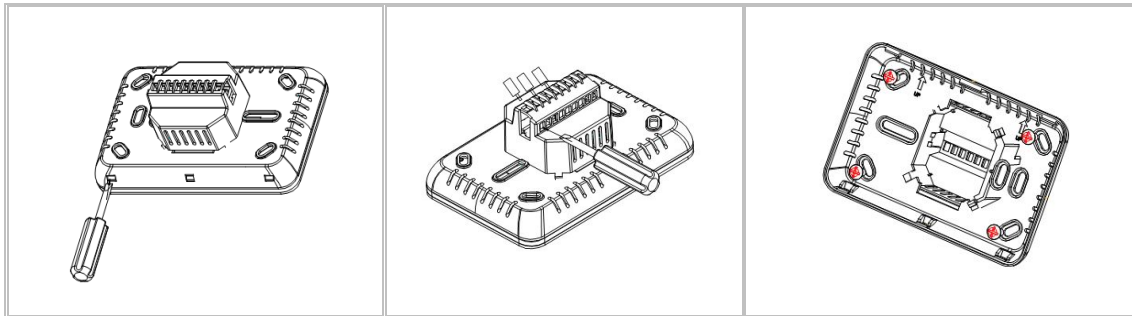

Dimension (mm)

